



Hold, Charge and Protect your iPad



OPEN
Room #1010

3:56
Monday, Mar 19

- Today**
- Off Site Security Webinar 9:00 - 9:30
- Tomorrow**
- Security Details 10:00 - 11:00
 - Party Planning Coordination 2:00 - 4:00
 - Finance Conference 8:00 - 5:00
 - Staff Update 9:00 - 9:30
- Mar 21, 2018

Reserve

HOLD, CHARGE, PROTECT

Beginning in 2004 with the aim of integrating Apple products with home and office environments, iPort invented the world's first in-wall dock for iPod, the world's first in-wall mount for iPad and iPod Touch, and LaunchPort - the world's first and only inductive charging system for iPad.

Today iPort's products are used in residences and commercial spaces across the world. Room-to-room at home and in hotels, corporate offices, yachts - even in aircraft - they enhance the way you work with and enjoy the best that mobile technology can offer.



Why the iPad is Shaping the Future of Control	Page 4
LuxePort, luxury iPad mounting and charging system for wall or desktop	Page 6
Surface Mount on-wall mounting and charging system for iPad	Page 10
Surface Mount with Buttons on-wall mounting and charging system for iPad, which combines Apps with control system buttons	Page 14
LaunchPort iPad mounting and charging system for wall or desktop	Page 16
Charge Case & Stand 2 desktop charging and mounting system for iPad	Page 18
iPort / iPad compatibility chart	Page 20
xPRESS audio control keypad for Sonos	Page 23

Why the iPad is Shaping the Future of Control

Control over AV entertainment, lighting, heating and security at home and at work is changing. The exponential growth in Internet capacity, speed and reach has shifted the focus away from proprietary systems, which rely on third-party APIs and drivers, to the infinitely more powerful App-based control platforms found on everyday smartphones and tablets.

These offer you an easy way to interact with ballooning numbers of next-gen Internet of Things (IoT) devices including Nest, Alexa and Ring. IoT systems create their own secure links through a firewall to dedicated servers in the cloud. This means that rather than have a third-party control system interpret their communications, they can send and receive data directly for a near instantaneous response to Apps sitting on your tablet, and get upgrades in the same seamless way. What's more, it doesn't matter whether you're at home, at work or on holiday, the control just works.

With superior looks, speed, and functionality, the iPad is perhaps the best example of a future control screen, available today. For any device or system with a control App, the iPad is your dashboard.

This is why iPort has engineered so many ways to hold, charge and protect it.



Advantage iPad

User experience (UX) with video and audio: there is no question that native iOS Apps for music and video streaming devices are better looking, more intuitive and interactive than the user interfaces of proprietary control screens. With an iPad App-based solution you have the best of both worlds: command over the control system and media players/IoT devices from native interfaces designed by their providers.

Speed: iPads have significantly more processing power than proprietary screens, resulting in a better user experience (UX) with animation. Natively they support the latest H.264 and H.265/HEVC video CODECs for smoother and faster video streams (from security devices for example).

Greater resolution: iPads support retina resolution, a minimum pixel count of 2048 x 1536 at 264-326ppi. In contrast Savant's Wally 5.5 has a resolution of 1280 x 720 and Control4's T3 (7 or 10-inch) has a resolution of 1280 x 800.

Alexa: voice activated control is nice, but it's even better when you can use your iPad as well. The Alexa App for iOS not only provides reminders from your Alexa devices, but also allows you to "drop-in" or intercom either Alexa devices or other Alexa users around the house.

Multitasking: iPads can run multiple applications at once and push notifications like camera security alerts, doorbells and VOIP calls. The latest iOS Version (11) introduces a better split-screen feature, where two applications can run simultaneously in one window. The middle image shows MusicCast music streaming on one side and SimpleControl on the other.

Orientation: portrait orientation is becoming more popular with consumers as it provides a similar interface to the one they use on their smartphones. There are more apps designed to work in portrait mode than landscape. iPort's Surface Mount and LuxePort systems can be used in either orientation.



LUXEPORT - The next level of iPad charging and mounting

LUXEPORT is a deluxe iPad charging and mounting system for tabletop and wall locations. It's an iPad Case + Station system, precision engineered and hand-finished in durable, portable high grade aluminium alloy. You can mount and charge the iPad in portrait or landscape positions via PoE or Low Voltage wiring from 8cm square WallStations, or mount, charge and view iPad at virtually any angle from tabletop BaseStations. Robust security allows for total lock down of Case and Station to a table or wall. Available in a choice of black, white or silver finishes.



The Case

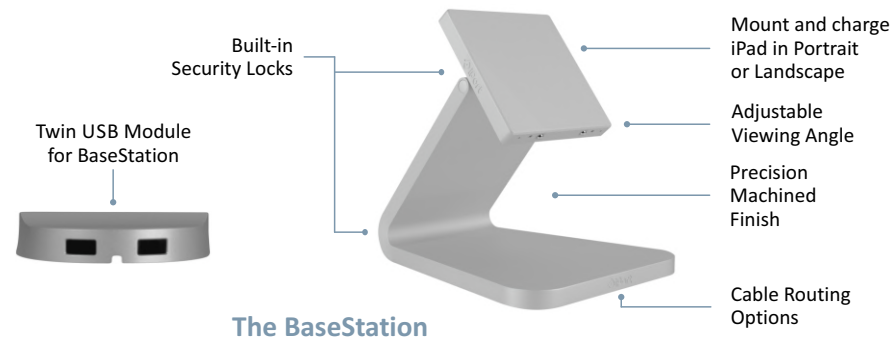

The BaseStation

Features & Benefits

- Deluxe iPad charging and mounting system for tabletop and wall
- Case + Station system precision engineered and hand finished in durable, portable high grade aluminium alloy
- Mount, charge and view iPad in portrait or landscape positions via PoE or Low Voltage wiring from 8cm square WallStations or from tabletop BaseStations. USB Module adds twin Ports to BaseStation
- Robust security allows for total lock down of Case and Station to a table or wall
- Hold | Charge | Protect | Pro 10.5" • All 9.7" iPads • mini 4

Finishes:

Black

White

Silver



The WallStation



Refined Aesthetics



Home Base for iPad



Flexible Installation



LUXEPORT - The next level of iPad charging and mounting

LuxePort Security

With premium features like a security locking system that allows for total lock down of Case and Base/WallStations to a table or wall surface, LuxePort is the perfect home for iPad even in the most demanding commercial environments. When locked, two pins extend from the Wall or BaseStation to secure the Case in position.

Case iPad Pro 10.5"

Weight: 0.37 Kg

SKUs:
IPO-71015 (Black)
IPO-71016 (Silver)
IPO-71017 (White)

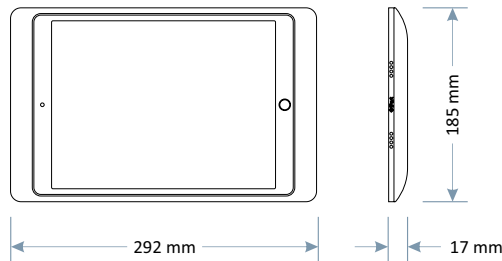

BaseStation

Weight: 1.42 Kg

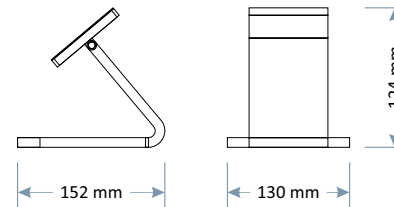

SKUs:
IPO-71000 (Black)
IPO-71001 (Silver)
IPO-71002 (White)

Case All 9.7" iPads

Weight: 0.34 Kg

SKUs:
IPO-71012 (Black)
IPO-71013 (Silver)
IPO-71014 (White)

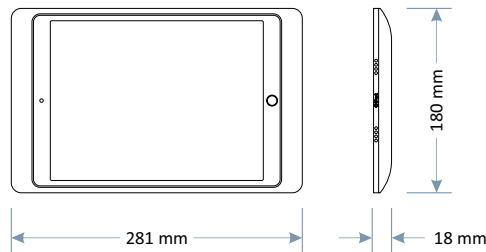

WallStation

Weight: 0.2 Kg

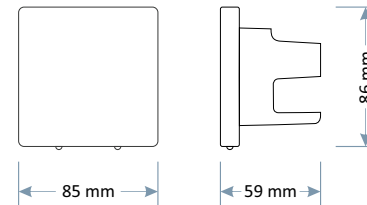

SKUs:
IPO-71003 (Black)
IPO-71004 (Silver)
IPO-71005 (White)

Wall Adapter Kit

Weight: 0.25 Kg

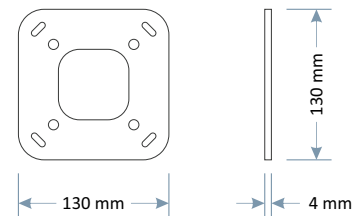

SKUs:
IPO-71006 (Black)
IPO-71007 (Silver)
IPO-71008 (White)

Case iPad mini 4

Weight: 0.28 Kg

SKUs:
IPO-71009 (Black)
IPO-71010 (Silver)
IPO-71011 (White)

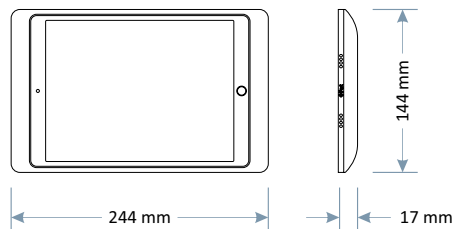

USB Charge Module

Weight: 0.24 Kg

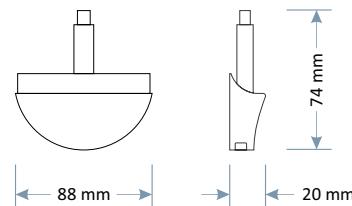

SKUs:
IPO-71018 (Black)
IPO-71019 (Silver)
IPO-71020 (White)

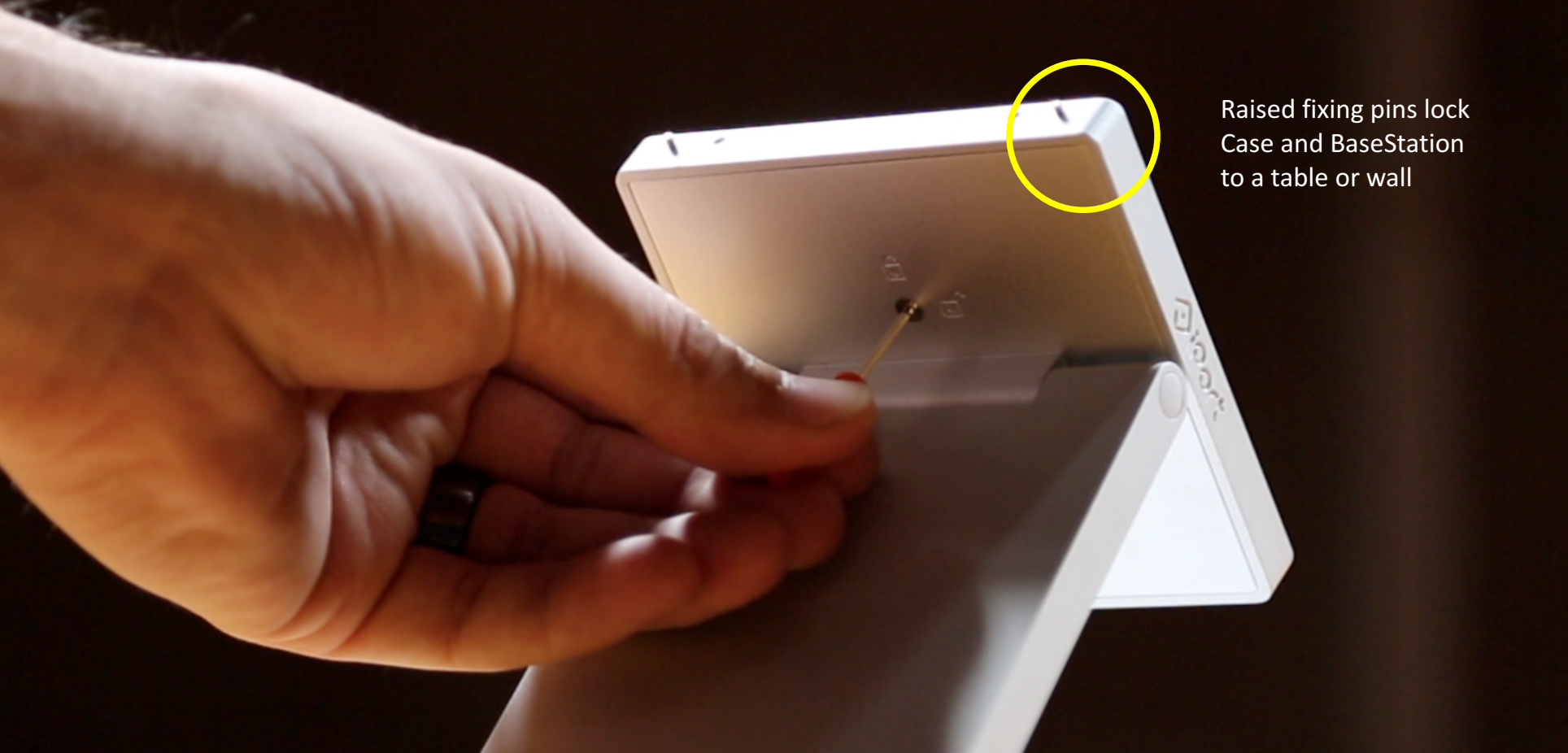

Raised fixing pins lock Case and BaseStation to a table or wall



Surface Mount - Elegantly integrate iPad with any wall surface

Turn your iPad into a smart touch controller with Surface Mount: the elegant frame that allows you to integrate iPad with any wall surface. Surface Mount is an on-wall iPad charging and mounting system, comprising a magnetic Bezel + Bracket assembly. The Bezel surrounding the iPad is precision engineered in high grade aluminium alloy with black, white or silver finishes. Simply snap the iPad into the Bezel and then onto the mounting bracket using the power of magnets: hold the Bezel above the mounting bracket and it snaps right into place.

Mount and charge iPad in portrait or landscape positions via a PoE splitter/ injector. There's an integrated security lock and the Bezel design maintains access to iPad power/mic/sound.



Features & Benefits

- Surface Mount on-wall iPad charging and mounting system
- Magnetic Bezel + Bracket system. Bezel precision engineered in high grade aluminium alloy
- Mount and charge iPad in portrait or landscape positions via PoE splitter/injector. Use any wall box worldwide
- Integrated security lock, access iPad power/mic/sound
- Hold | Charge | Protect | Pro 12.9" • Pro 10.5" • All 9.7" iPads • mini 4|3|2|1
- Achieve flawless flush integration of iPad and wall surface with optional TruFig mounting platforms, available separately
- Supports App multi-tasking requires iOS 11
- Apple networking dongles enable wired control where preferable to wi-fi

- Finishes: Black White Silver



Precision-machined Bezel, high grade finishes

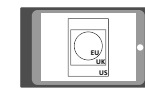

Install on any surface, use any wall box



Flexible power options via PoE or low voltage

Compatible with:





Flush mount options

For a flawless integration with décor, Surface Mount Bezels can fit flush into the wall using TRUFIG mounting platforms. The platforms are designed to work with a variety of surface finishes including gypsum, plaster, tile, wood, and stone to create the perfectly flush installation of the iPad with the wall surface. Available for Surface Mount for iPad Pro 12.9", iPad 9.7" and iPad mini 4.

Trufig 12.7mm Gypsum Platform:

- for iPad Pro 12.9" [\(TRU-51210\)](#)
- for all 9.7" iPads [\(TRU-51225\)](#)
- for iPad mini 4 [\(TRU-51217\)](#)

Trufig 12.7mm Solid Surface Platform:

- for iPad Pro 12.9" [\(TRU-51211\)](#)
- for all 9.7" iPads [\(TRU-51227\)](#)
- for iPad mini 4 [\(TRU-51219\)](#)



Surface Mount - Elegantly integrate iPad with any wall surface

Pro 12.9"

(Bezel + Splitter Bundle)

Weight: 1.1 Kg

SKUs:

IPO-70746 (Black)
IPO-70747 (Silver)
IPO-70748 (White)

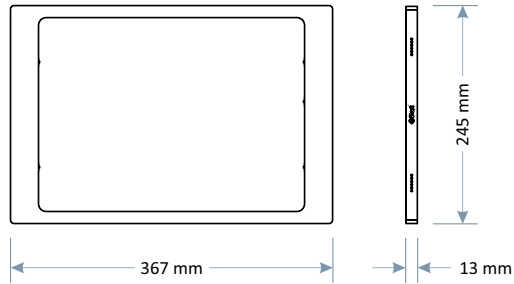

mini 4|3|2|1

(Bezel + Splitter Bundle)

Weight: 0.31 Kg

SKUs:

iPad mini 3|2|1 IPO-70734 (Black) IPO-70735 (Silver) IPO-70736 (White)
iPad mini 4 IPO-70740 (Black) IPO-70741 (Silver) IPO-70742 (White)

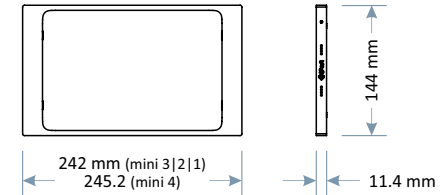

Pro 10.5"

(Bezel + Splitter Bundle)

Weight: 0.44 Kg

SKUs:

IPO-70900 (Black)
IPO-70902 (Silver)
IPO-70904 (White)

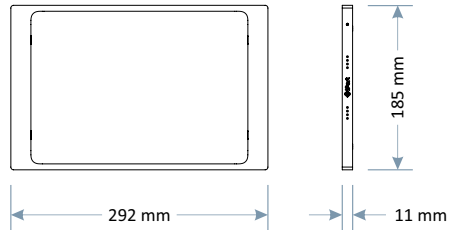

PoE Splitter

Weight: 0.06 Kg

SKU: IPO-70718

Power

Input: DC 56V, 0.275A or DC 36V - 57V, 0.4A (PoE IEEE 802.3 af)
Output: DC 5V, 2.4A max
AUX/Input: DC 5V, 18 - 24V, 0.8A

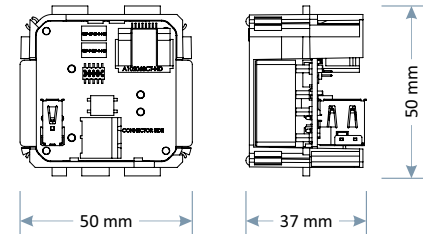

All 9.7" iPads

(Bezel + Splitter Bundle)

Weight: 0.44 Kg

SKUs:

IPO-70737 (Black)
IPO-70738 (Silver)
IPO-70739 (White)

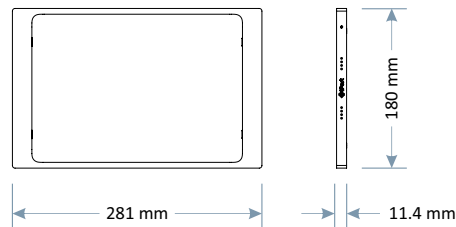

PoE Injector

Weight: 0.1 Kg

SKU: IPO-70719

Power

Input: AC 110 - 240V ~ 50/60 Hz 0.5A
Output: PoE IEEE 802.3 af

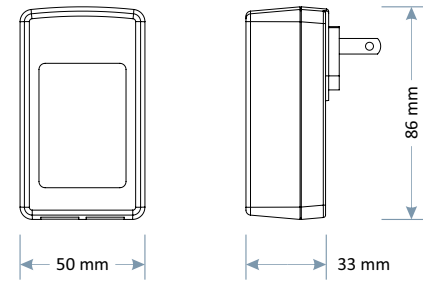

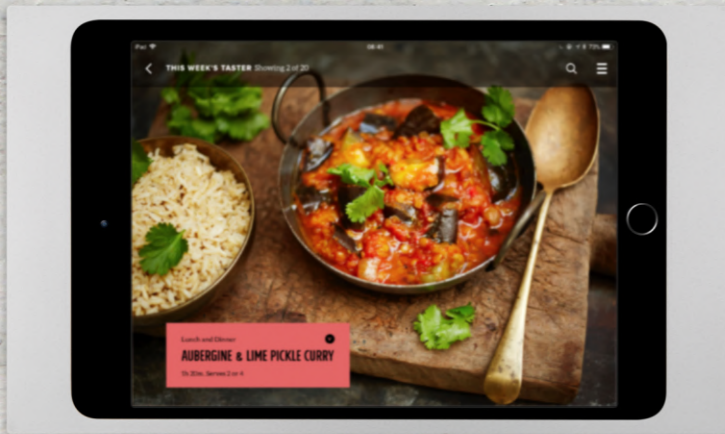

Surface Mount with Buttons - Combine iOS Apps with system control buttons

Surface Mount with Buttons offers the optimum home control interface by combining the richness of iPad apps with an array of hard buttons wired to network switches for immediate access to primary control system functions.

Surface Mount with Buttons is available in six and ten button versions. The buttons communicate using unique JSON commands over a single PoE connection via IP directly to the control system processor. Each engraved button is LED backlit, revealing icons representing key functions of the control system. A choice of buttons is supplied and custom-engraved buttons can be ordered. Button brightness and colour can be programmed according to application and for added design versatility, a single button space can accommodate a multi-function or single function action.

Flush mount options

For a flawless integration with décor, Surface Mount Bezels can fit flush with the wall using TRUFIG mounting platforms. The platforms are designed to work with a variety of surface finishes including gypsum, plaster, tile, wood, and stone to create the perfectly flush installation of the iPad with the wall surface. Available for Surface Mount with Buttons for iPad Pro 12.9", iPad 9.7" (all variants) and iPad mini 4.

Trufig 12.7mm Gypsum Platform: for iPad Pro 12.9" ([TRU-51210](#)) for all 9.7" iPads ([TRU-51221](#)) for iPad mini 4 ([TRU-51213](#))
Trufig 12.7mm Solid Surface Platform: for iPad Pro 12.9" ([TRU-51211](#)) for all 9.7" iPads ([TRU-51223](#)) for iPad mini 4 ([TRU-51215](#))

Compatible with:



Features & Benefits

- 6 and 10 Button models
- Buttons in black or white according to bezel finish
- Includes 30+ icon-engraved buttons. Custom buttons are available to order separately
- Hold | Charge | Protect | Pro 12.9" • All 9.7" iPads • mini 4

• Finishes:

Black

White

Silver



Buttons System Pro 12.9"

Weight: 1.1 Kg

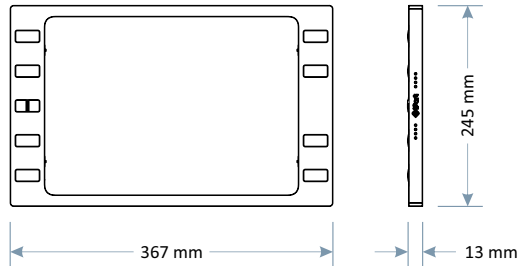

SKUs (10 buttons): IPO-70781 (Black), IPO-70782 (Silver), IPO-70783 (White)
 SKUs (6 buttons): IPO-70778 (Black), IPO-70779 (Silver), IPO-70780 (White)

Buttons System All 9.7" iPads

Weight: 0.59 Kg

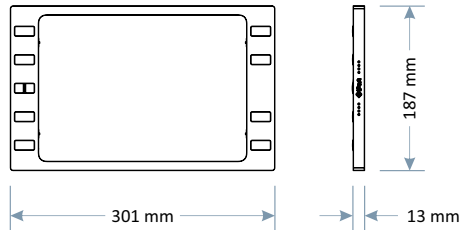

SKUs (10 buttons): IPO-70761 (Black), IPO-70762 (Silver), IPO-70763 (White)
 SKUs (6 buttons): IPO-70767 (Black), IPO-70768 (Silver), IPO-70769 (White)

Buttons System mini 4

Weight: 0.49 Kg

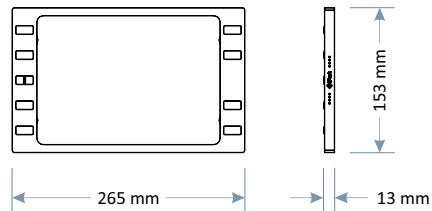

SKUs (10 buttons): IPO-70758 (Black), IPO-70759 (Silver), IPO-70760 (White)
 SKUs (6 buttons): IPO-70764 (Black), IPO-70765 (Silver), IPO-70766 (White)

PoE Splitter

Weight: 0.06 Kg

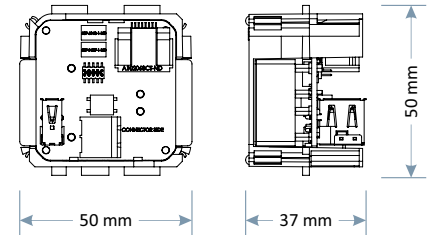

SKU: IPO-70718

Power

Input: DC 56V, 0.275A or DC 36V - 57V, 0.4A (PoE IEEE 802.3 af)
 Output: DC 5V, 2.4A max
 AUX/Input: DC 5V, 18 - 24V, 0.8A

PoE Injector

Weight: 0.1 Kg

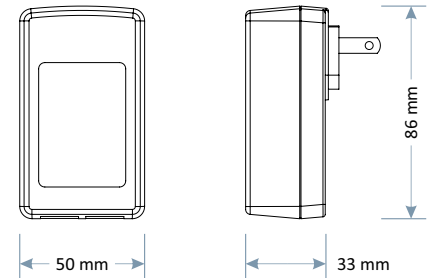

SKU: IPO-70719

Power

Input: AC 110 - 240V ~ 50/60 Hz 0.5A
 Output: PoE IEEE 802.3 af



LaunchPort - The World's First and Only Inductive Charger / Magnetic Mount for iPad

LaunchPort is the revolutionary charging and mounting system that powers iPad via inductive charging. The system comprises a Station and a Sleeve, which slides onto iPad. There are two types of Stations: a BaseStation which can be placed on a table or counter and a WallStation which can be installed into nearly any surface. The WallStation is powered in-wall, with low-voltage wires routed back to a power source.

As soon as a Sleeve is mounted to a Station, charging begins immediately, without wires or cables. Magnets are used to mount an iPad-in-Sleeve to a Station. Because magnets are inside the Sleeve, you can also mount it to any metallic surface.

Features & Benefits

- iPad charging and mounting system for tabletop and wall installations
- Sleeve + Station system: mount and charge iPad in portrait or landscape positions via inductive charging through WallStations and tabletop BaseStations
- Hold | Charge | Protect | All 9.7" iPads (AP.5) • mini 4|3|2|1 (AM.2)

• Finishes:

Black

White



BaseStation



WallStation



Sleeve



Protection in an Elegant Case



Magnetic Mounting



Home Base for iPad



Inductive Charging



Convenient Wireless Charging

Sleeve AP.5

Weight: 0.33 Kg

Power

Input: 15V, 2A

Output: 5.2V, 2.4A

SKUs:

IPO-70300 (Black)

IPO-70301 (White)

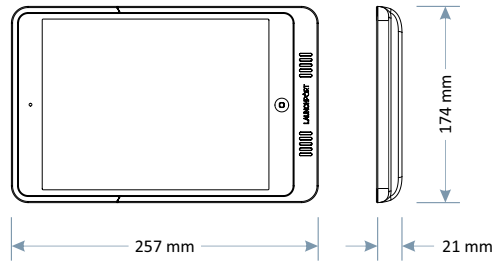

Sleeve AM.2

Weight: 0.33 Kg

Power

Input: 15V, 2A

Output: 5.2V, 2.4A

SKUs:

IPO-70304 (Black)

IPO-70305 (White)

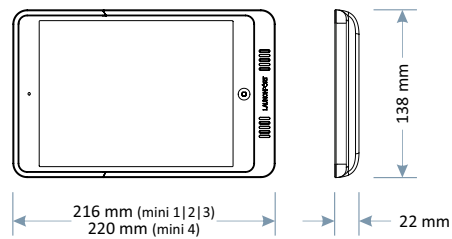

WallStation

Weight: 0.28 Kg

Power

Input: 110 - 240V AC

Output: 15V, 2A

SKUs:

IPO-70170 (Black)

IPO-70142 (White)

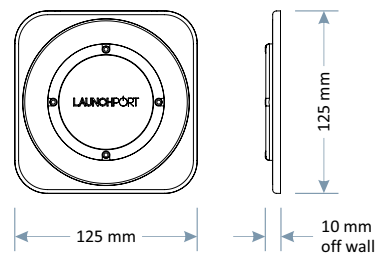

BaseStation

Weight: 1.6 Kg

Power

Input: 110 - 240V AC

Output: 15V, 2A

SKUs:

IPO-70158 (Black)

IPO-70141 (Silver)

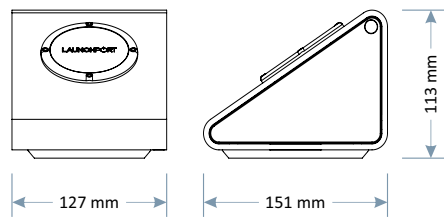

Charge Case & Stand 2 - Table-Top Wireless Charging & Mounting System

Use your iPad while it charges and keep it protected on the go. The Charge Stand 2 accepts and charges your iPad in its Charge Case in either portrait or landscape orientations. As you place your Charge Case onto a Charge Stand, magnets auto-align the case for charging and secure mounting. USB ports on the side of the Stand 2 can charge up to two additional mobile devices.



Features & Benefits

- iPad charging and mounting system for table-top
- Case + Station system: mount and charge iPad in portrait or landscape positions via conductive charging through tabletop Charge Case & Stand.
- Charge up to two additional mobile devices through 2 x USB ports on Stand
- Hold | Charge | Protect | All 9.7" iPads • mini 1|2|3|4
- Perfect for bed-side, conference room, table or kitchen counter storage and charging
- Finishes: Black



Charge Case All 9.7" iPads

Weight: 0.2 Kg

Power

Input: 5V, 2.4A DC

Output: 5V, 2.4A DC

SKU: IPO-70206

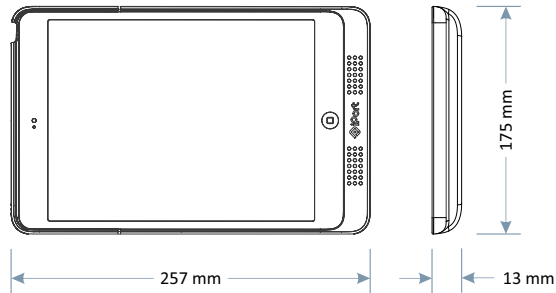

(Includes Stand 2 and Power Supply)

Charge Case mini 4|3|2|1

Weight: 0.13 Kg

Power

Input: 15V, 2A

Output: 5.2V, 2.4A

SKU: IPO-70216

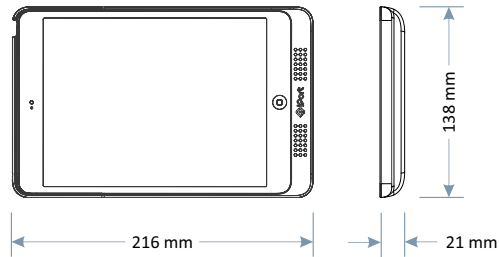

(Includes Stand 2 and Power Supply)

Stand 2

Weight: 0.8 Kg

Power

Input: 100 - 240V AC ~
50/60Hz, 0.5A

Output: 5V, 2.4A DC and
5V, 1.2A DC (x 2 aux USB)

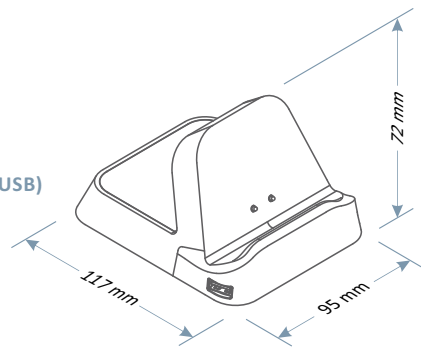

iPort / iPad - Compatibility Chart

		Stationary On Wall			Removable On Wall and / or Table Top			
	LuxePort	Surface Mount System (Bezel + Splitter)	Surface Mount with Buttons System (Bezel + Splitter)		LaunchPort Sleeve (Station Sold Separately)		Charge Case & Stand	xPRESS Audio Keypad
	Case		6 Button System	10 Button System	AP.5 Sleeve	AM.2 Sleeve		
Pro 12.9"		IPO-70746 (Black) IPO-70747 (Silver) IPO-70748 (White)	IPO-70778 (Black) IPO-70779 (Silver) IPO-70780 (White)	IPO-70781 (Black) IPO-70782 (Silver) IPO-70783 (White)				IPO-70800 (White)
Pro 10.5"	IPO-71015 (Black) IPO-71016 (Silver) IPO-71017 (White)	IPO-70900 (Black) IPO-70902 (Silver) IPO-70904 (White)		Available 2018				
Gen 5 9.7" Pro 9.7" Air 1 2	IPO-71012 (Black) IPO-71013 (Silver) IPO-71014 (White)	IPO-70737 (Black) IPO-70738 (Silver) IPO-70739 (White)	IPO-70767 (Black) IPO-70768 (Silver) IPO-70769 (White)	IPO-70761 (Black) IPO-70762 (Silver) IPO-70763 (White)	IPO-70300 (Black) IPO-70301 (White)		IPO-70206	
mini 4	IPO-71009 (Black) IPO-71010 (Silver) IPO-71011 (White)	IPO-70740 (Silver) IPO-70741 (Silver) IPO-70742 (White)	IPO-70764 (Black) IPO-70765 (Silver) IPO-70766 (White)	IPO-70758 (Black) IPO-70759 (Silver) IPO-70760 (White)		IPO-70304 (Black) IPO-70305 (White)	IPO-70216	
mini 3 2 1		IPO-70734 (Black) IPO-70735 (Silver) IPO-70736 (White)						
Accessories and System parts	BaseStation IPO-71000 (Black) IPO-71001 (Silver) IPO-71002 (White) WallStation IPO-71003 (Black) IPO-71004 (Silver) IPO-71005 (White) Wall Adapter Kit IPO-71006 (Black) IPO-71007 (Silver) IPO-71008 (White) USB Charge Module IPO-71018 (Black) IPO-71019 (Silver) IPO-71020 (White)		PoE Splitter IPO-70718 PoE Injector IPO-70719 Glass Mounting Kit IPO-70720 Data Cable IPO-70791			BaseStation IPO-70158 (Black) BaseStation IPO-70141 (Silver) WallStation IPO-70170 (Black) WallStation IPO-70142 (White)		





iPort

xPRESS - The Audio Keypad for Sonos

So much faster than an App, the world's first Wi-Fi keypad dedicated to Sonos® makes direct control of any Sonos device easy from anywhere. Paired with any Sonos device through Wi-Fi, xPRESS controls play/pause, track forward, volume, Sonos favourites and your entire Sonos home sound system when grouped in party mode.

The xPRESS Wi-Fi keypad is designed to be eminently portable: a rechargeable lithium polymer battery provides 4-6 months of power with normal use, so you're free to control your music room-to-room from the palm of your hand. Store it within reach on a kitchen appliance (xPRESS is magnetic) or on-wall in seconds using the wall-plate adaptor supplied.

Set up is easy through the iPort Connect App available on the App Store: simply choose network and which Sonos to control. The xPress Audio Keypad is an Endorsed Integration Partner with Sonos.

Features & Benefits

- World's first WiFi keypad for Sonos
- Play / Pause /Track Forward / Volume
- Favourites: direct access to your Sonos favourites! Toggle between Spotify Playlists, Pandora Stations etc. Control your entire Sonos home system when in party mode
- Easy setup with iPort Connect App available from App Store
- Easy to Install on-wall: takes less than a minute with included wall-plate adaptor
- Battery powered and magnetic: carry and store room-to-room
- With v2.1 firmware:
 - Individual Zone Volume Control
 - Selected favourites
 - Automate Sonos with the creation of scenes



Wi-Fi



Battery Powered



Easy App Setup



Magnetic Mounting

Play / Pause



Track Forward



Favourites



Volume



SKU: XPR-70800



DANA INNOVATIONS

+44 (0)1256 638500 www.habitech.co.uk

